



XPS Continues to Provide High Quality Service for the Global Minerals Industry

Last May 2013, the merger of Glencore and Xstrata was completed, creating a vertically integrated leader in the natural resources sector. XPS Consulting & Testwork Services is proud to be part of the dynamic Glencore group. We have changed our name to XPS (previously Xstrata Process Support) to better reflect the independent, high quality technical support that we provide to the broader minerals industry.

Glencore has operations in every corner of the globe in Metals and Minerals, Coal, Oil and Gas and Agriculture. Their unique business model as a vertically integrated producer and marketer of commodities yields insights into each stage of the commodities chain, from extraction and processing to freight, logistics, technology, storage and marketing. The Technology businesses with Glencore include XT (previously Xstrata Technology) the providers of equipment such as IsaMills™, Jameson Cells, IsaSmelt™, IsaKidd™ and Albion Processes™; and of course XPS, the discipline leader in Process Mineralogy and Plant Support, Process Control, Materials Technology and Extractive Metallurgy. These technology businesses are independent busi-

nesses within the Group, separate from any commodity business. This means XPS brings to our clients a deep understanding of a wide range of commodities, operations, and the entire value chain, while providing independent and fully confidential support for all our clients.

XPS and XT have been long-time “siblings” and have operated effectively in their respective areas of specialization, while ensuring they each provide the best independent professional advice. We plan to expand this collaboration into the new area of Engineering Services. I welcome you to read the article on page 4 to learn more about this unique blend of lab and pilot testing, flowsheet development, mechanical/electrical/structural engineering design and commissioning services ranging from plant optimization projects to medium- and large-scale green and brownfield expansions.

Our owner has changed but our mandate remains the same, to deliver high quality, independent metallurgical consulting and testwork services to the global minerals industry. The enclosed

articles are but a sample of the value added project and plant support services that XPS has provided over the last 6 months.

We welcome you to contact us to discuss your process challenges and we hope you enjoy the Winter 2014 edition of the XPS Bulletin.

Dominic Fragomeni
 Director, XPS
dominic.fragomeni@xps.ca

XPS Consulting & Testwork Services

GLENCORE

Metals & Minerals		Energy	Agriculture
Copper	Iron Ore	Technology	Coal
Nickel	Ferroalloys	XT	Oil
Zinc	Aluminum	<p style="margin: 0;">Joe Pease Process Equipment Applications, Engineering Sales Installation and Service</p> <div style="background-color: #a52a2a; color: white; padding: 2px; text-align: center; margin: 5px 0;">XPS</div> <p style="margin: 0;">Dominic Fragomeni Consulting & Testwork Services Business</p>	

Innovative New Green Technology for Ring of Fire Chromite Ore from KWG

XPS is working with KWG Resources to find innovative ways to process Ring of Fire Chromite ore. The work is in the early stages of development; however, the preliminary tests have been successful.

In the new process, chromite is reduced in its solid state to metallic ferrochrome instead of in a conventional smelter. This reduces the energy consumption and process complexity. Natural gas, readily available in Ontario, is used to replace electricity, further reducing production costs.

The scoping level work has yielded promising results. The next stage of the program is to demonstrate the results at a larger scale and determine engineering design criteria for a full scale commercial operation.

Mika Muinonen
 Manager, Extractive Metallurgy
 mika.muinonen@xps.ca

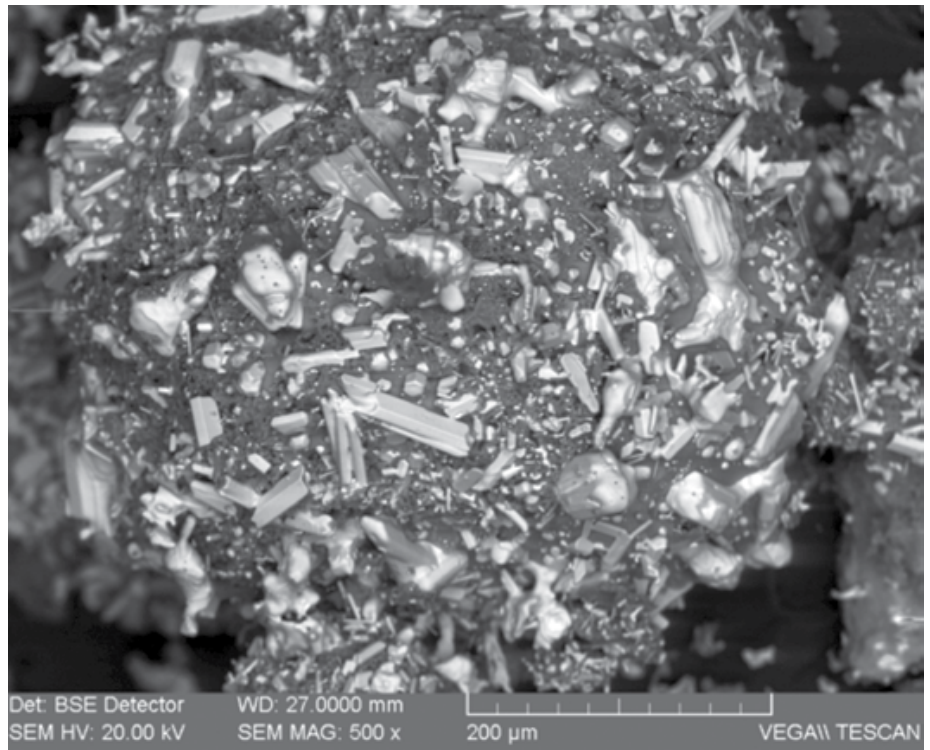

Scanning electron micrograph of reduced chromite ore.

In this issue

New Year, New Name,
 Same High Quality Service for the
 Global Mining Industry..... 1

Innovative New Green Technology for
 Ring of Fire Chromite Ore from KWG . 2

XPS Smelts Ring of Fire
 Chromite Ore for KWG 3

Mineralogical Measurement of
 Hi Vol Filters 3

XPS Partners with XT (Xstrata
 Technology) to provide Engineering
 Services 4

Koniambo Nickel SAS Furnace and
 Power Generation Control 6

Instrumentation at Altyntau Resources
 Vasilkovskoye Gold Mine 8

Modern Practice of Sampling and
 Flotation Testing 9

EIT Experience: From the Great White
 North to Down Under 10

To Receive XPS Bulletin

If you would like to receive a copy of the XPS Bulletin please e mail your details to rhonda.joly@xps.ca

Look us up on SAMSSA

XPS can also be found in the Sudbury Area Mining Supply & Service directory



XPS Consulting & Testwork Services

6 Edison Rd., Falconbridge, ON, P0M 1S0
 Tel: +1 (705) 699 3400, #3401
 Fax: +1 (705) 699 3431
 dominic.fragomeni@xps.ca
www.xps.ca

XPS Smelts Ring of Fire Chromite Ore for KWG

XPS successfully completed a smelting campaign on Ring of Fire chromite ore using their state of the art DC Arc furnace.

For the KWG test, Ring of Fire chromite ore from their Black Horse deposit was blended with coal, limestone and silica flux and charged to the furnace at a rate of 100 kg/hour using an accurate loss-in-weight feeder. The integrated process control system controlled the ratio of electrical power to feed to achieve the target temperature of ~1650°C.

The main conclusions from the tests completed for KWG are that: “Black Horse chromite ore smelts readily and produces both a high grade alloy and low Cr values in the discard slag. Cr recoveries were above 95%, higher than typical commercial chromium operations.”

The 350 kW DC Arc furnace at XPS was installed in 2011 and is available for electric furnace piloting and smelting of a broad range of feeds.

*Arthur Barnes
Principle Metallurgist, Extractive Metallurgy
arthur.barnes@xps.ca*



XPS employee tapping the DC arc furnace.

Mineralogical Measurement of Hi-Vol Filters

XPS has used QEMSCAN (Quantitative Evaluation of Materials by Scanning Electron Microscope) to evaluate the particulate matter in hi-vol samplers. Hi-vol air samplers are positioned near many operations and allow for continuous sampling of air quality. After a specified period of time, the filters are retrieved and sent for assay. In cases where there is a metal exceedance based on government regulated limits, the filters can be sent for mineralogical examination in order to characterize the particulate matter on the filter.

The samples are unusual in that they are not mounted in a flat polished section. Rather, the raw filter is carbon coated and placed directly in the SEM for measurement. A Quanta 650 FEG instrument has provided the resolution required for detailed characterization. Both particulate matter and the filter are measured and once complete, the filter is digitally removed during the data processing

phase of work. The figure (below) shows the transition from backscattered electron images to the QEMSCAN false coloured images and the processed particulates where the filter has been digitally removed. Each colour in the QEMSCAN image represents a different mineral phase, identified by its unique x-ray spectrum.

Mineralogical measurement of hi-vol filters can provide a robust assessment of the types of particulates in the air at the time of sampling, the intensity of particu-

late loading and the grain sizes of the individual particles. Results of the analysis can assist personnel in developing strategies to mitigate risks associated with dust that may originate from their operations.

Contact Michelle Kelvin or Lori Kormos for additional information.

*Lori Kormos
Principle Geo Scientist,
Process Mineralogy,
lori.kormos@xps.ca*

Backscattered electron images, QEMSCAN images, and particulate matter with filter removed.

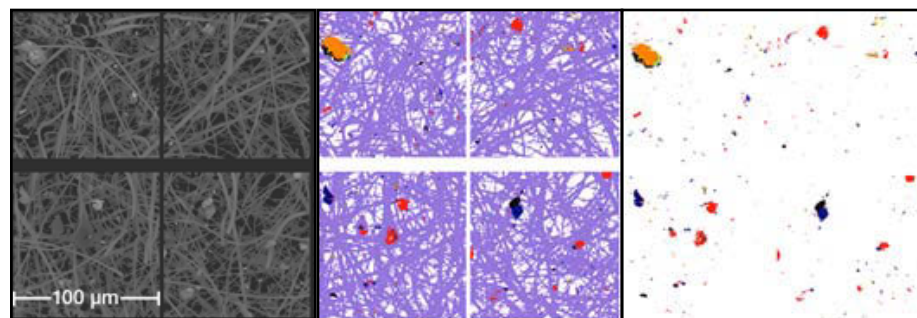

XPS Partners with XT (Xstrata Technology) to provide Engineering Services

Since 2007 XPS has provided complete flowsheet and process development services for a range of commodities including Geomet Unit selection, modeling, lab scale batch testing, pilot plant demonstrations and techno-economic studies. Over the last several years, these activities have resulted in Process Design Basis being produced for our clients who then proceed to engineering and cost estimation and in certain cases, construction of the flowsheet. Examples include, the Montcalm circuit, Kabanga Concentrator and changes to the Strathcona Mill flowsheet to treat the GeoMet Units from Nickel Rim South Mine in Sudbury.

XPS is pleased to announce that we can now incorporate mechanical, electrical and civil engineering into our product offerings by partnering with long time “sibling”, XT (Xstrata Technology). XT has a long history of engineering of large scale IsaSmelt™, IsaMill™, IsaKidd™ and Albion Process™ installations

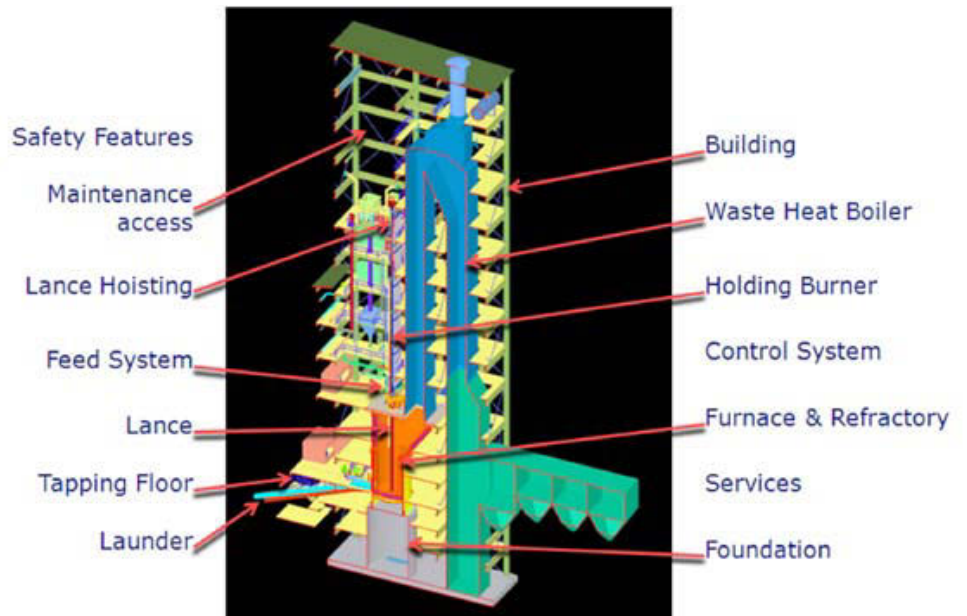

Sectional View of 3D-Model of IsaSmelt™ Plant

Cu ISASMELT™ Ust-Kamenogorsk, Kazakhstan, 290,000 t/y Cu Concentrate



including all the process equipment layout, process control and electrical, structural and mechanical ancillaries. XT has engineered and supplied critical equipment to over 18 IsaSmelt™ installations with a total project installed value of several billion dollars in every corner of the globe. From its engineering offices in Brisbane, Australia and Vancouver, Canada, XT provides services from over 100 engineers, layout draftsman, estimators and procurement services personnel.

The distinct advantage of the XPS-XT Engineering Service is the operations/maintenance experience we bring to the project as we are aware, first-hand, what is needed for a successful “Type 1” start-up. This experience is embedded in the project team from process design to conceptual engineering to operations training and commissioning support. XPS-XT Engineering can work with other engineering firms in providing all facets of the E-P-C-M cycle and can estimate and install all manner of process equipment. This partnership will enable XPS to provide solid process performance guarantees when appropriate.

The partnership between XPS and XT is unique to the industry where flow-sheet development/testwork/piloting, process control system design, materials technology and design and process, mechanical/electrical/structural design, and training/installation/commissioning support can be delivered under one roof, from people with decades of experience operating the plants they design.

We welcome Requests for Proposal and enquiries at XPS and XT:

dominic.fragomeni@xps.ca
 Director, XPS
 705-699-3400

mbonislowski@xstratatech.com
 General Manager, Engineering
 604-699-6412

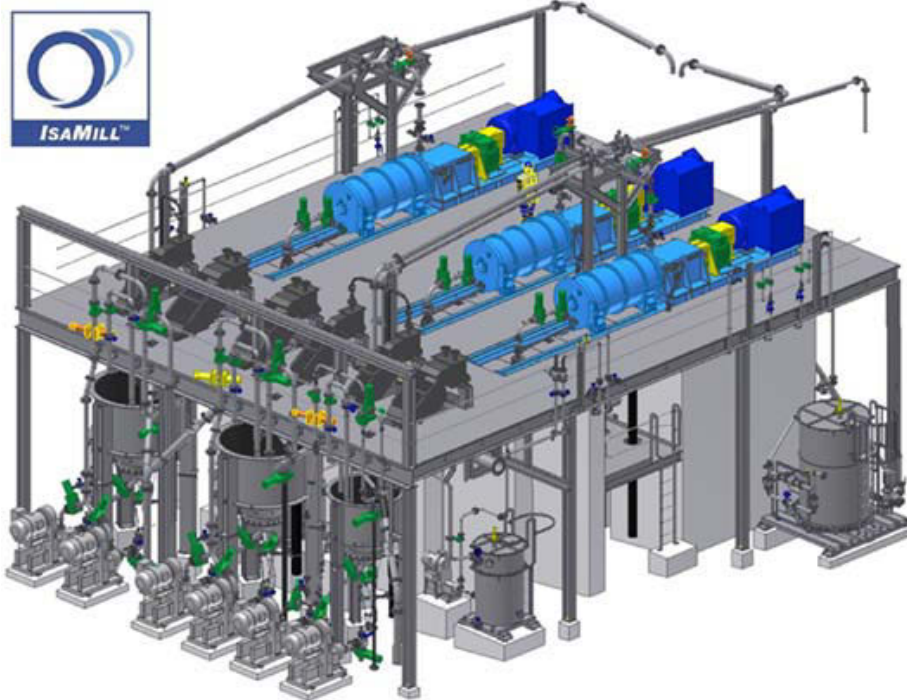

3-D Model of IsaMill Installation, Canada

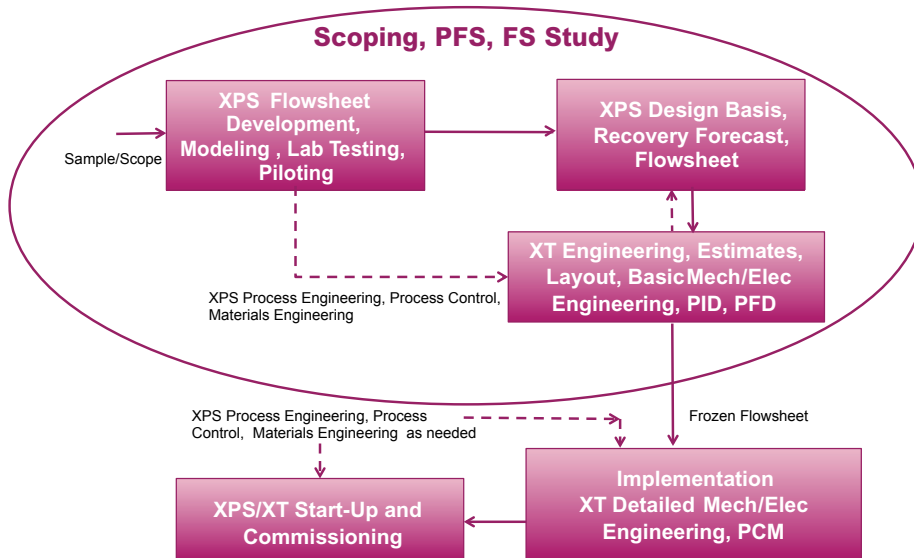

XPS – XT Engineering: From sample to process design to start-up.



Koniambo Nickel SAS Furnace and Power Generation Control

Commissioning an entire metallurgical complex requires a large team with diverse skill sets. Experts in relevant disciplines are required in addition to experts on the individual units within the complex. XPS Process Control had the opportunity to work with the Koniambo Nickel site Process Control group, Operations team, ABB High Power Rectifiers team and Hatch commissioning team on commissioning in the metallurgical furnace and power plant area. Koniambo Nickel operates a mine, a metallurgical nickel smelter, a power station and other supporting infrastructure in the North Province of New Caledonia. The smelter tapped its first nickel during the first quarter of 2013. It is being ramped up to achieve annual nameplate capacity of 60,000 tonnes of nickel in ferronickel.

A two-week 'quick strike' trip in September 2013 was organized to kick off the effort. Phil Nelson and Sigi Nino (contracted from Summa Control Solutions) travelled to New Caledonia to work with those on site. Kabir Ahmed, an XPS Process Control engineer on a one year work assignment at KNS, was a core member of the team. The assignment was to track down the cause of an undesirable variation in the power grid and eliminate it.

Complex systems composed of multiple parts can have unexpected behaviour which arises from the interaction between the parts. Process control engineers are accustomed to dealing with large systems and the time based interactions between components that can arise. The furnaces, combustion turbine generators, grid and static var compensator (SVC) components on the power bus shown below were the relevant parts (the steam turbines generators were yet to be commissioned). After determining the control structure of the major actors, a potential interaction between the generators and furnace voltage control was identified and a modification made to eliminate it. Variation in the furnace feed was also shown to have a large effect on the power system.

The cooperation has continued since the visit with Kabir representing the XPS Process Control group. The variation in the furnace feed has been dramatically reduced as shown in the trends, and further improvements have been made to the furnace power control. These efforts have contributed to increased stability in the plant power grid and smoother operation.

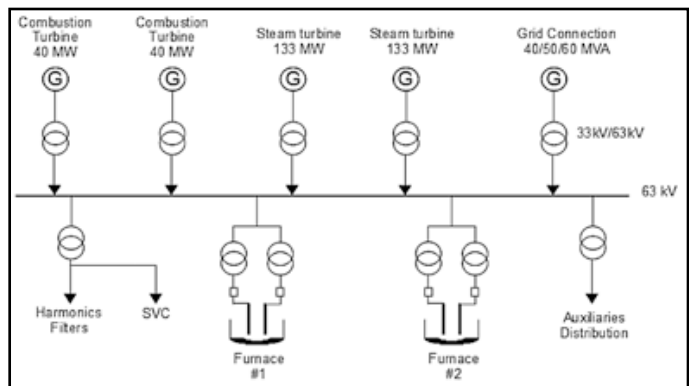

Power Distribution System

Feed and Bin discharge

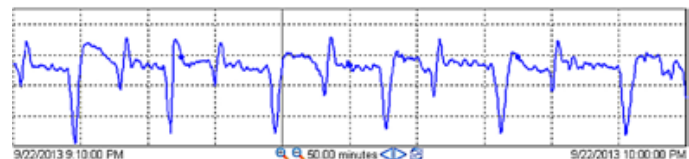

Before Control Modifications

Feed and Bin discharge

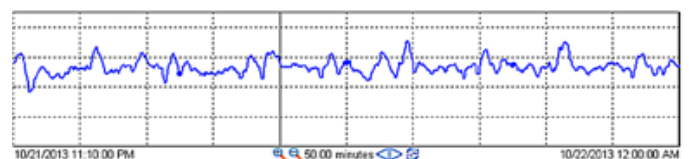

After Control Modifications

Philip Nelson (Phil.Nelson@xps.ca),
Kabir Ahmed, Sigi Nino (Summa Control Solutions)



Kabir Ahmed (XPS), Phil Nelson (XPS),
Thierry Bonnet de Larbogne (Koniambo),
Sigi Nino (Summa)

Instrumentation at Altyntau Resources Vasilkovskoye Gold Mine, Kazakhstan

In September 2013, Alan Hyde, Chief Process Control Engineer, visited the Vasilkovskoye Gold Mine in Kokshetau, Kazakhstan. Vasilkovskoye is one of the world's largest gold deposits, and processes up to 8 mt/y of ore to produce roughly 12 t/y of gold. The mine is an open pit operation with a large and fairly complex Gold Recovery Plant.

The objective of the visit was to assist Altyntau Resources with the selection of appropriate flow and density instruments for selected process streams in the Gold Recovery Plant. Some measurements will be used for metal balancing, whilst others will be used to improve the monitoring and control of the process. Through our work within GlencoreXstrata and external operations, along with continuous contact with instrumentation suppliers, the XPS Process Control Group is able to combine practical experience with knowledge of products to advise on instrumentation "best practices".

During the visit Alan worked with the plant Process Engineers and Instrument Maintenance Supervisor to review the application requirements, and to look at suitable locations for installation in the field. This included general discussions on the available flow and density measurement technologies for slurry applications, as well as how these relate to the AMIRA P754 Code of Practice for Metal Accounting. Based on the application requirements Alan was able to make recommendations on instruments for all the streams.

The various sampling systems in the plant were also reviewed, along with information provided from the Analytical Laboratory on sample preparation and analysis methods. With specialist support from Norm Lotter, XPS Consulting Metallurgist, and Dominic Fragomeni, XPS Director, feedback was also provided to the plant in this area.

The plant is also interested in applying on-line analyzers for particle size and elemental assays to improve real-time control and monitoring of the gold recovery process. These opportunities were reviewed with the plant and recommendations provided on suitable technologies and products for the applications.

Alan is continuing to assist with follow-up from the visit, and XPS looks forward to assisting Altyntau Resources in the future.

*Alan Hyde
Chief Engineer, Process Control,
alan.hyde@xps.ca*

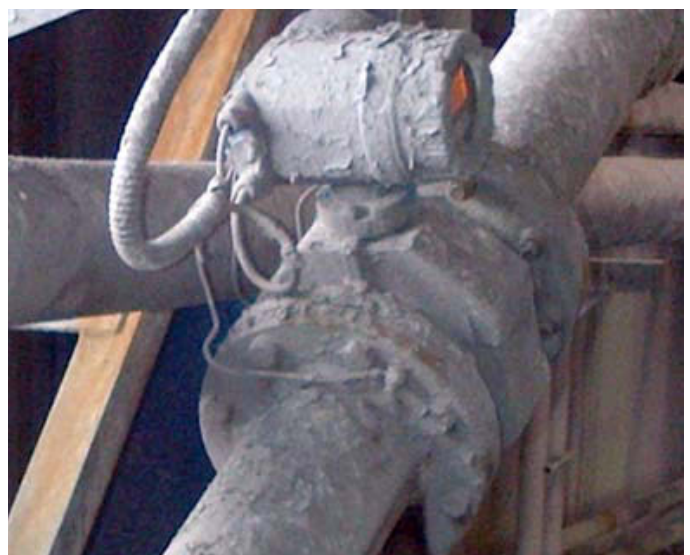

Modern Practice of Sampling and Flotation Testing

At the recent international MEI Flotation '13 conference held in Cape Town, South Africa, we presented a paper entitled "Modern Practice of Sampling and Flotation Testing", which was co-authored with Professor Dee Bradshaw, of the SMI JKMRRC, University of Queensland, Brisbane. The paper reviews the developmental history of modern process mineralogy across two generations, culminating in a description of our current best practice through a case study of the Ivanplats Kamoia project flowsheet development.

Process mineralogy has contributed significantly to flowsheet development by way of powerful information that reveals process implications, such as those resulting from grinding strategies or flotation selectivity challenges. The recent inclusion of best practice sampling has made a significant difference to the meaning of the laboratory testwork.

Two generations of improved practice were identified.

The first is when this practice was retrofitted to serve existing concentrators that had been conventionally designed. An example cited was the surveying and flowsheet improvement of the newly commissioned Raglan mill in 1997, which advanced metallurgical performance beyond design.

The second is serving new design opportunities before commissioning, where predictive value is added to the project with a more complete understanding of the process implications drawn from the sampling and characterisation of drill core. It has been shown that when these connections are made, and modern quality controls are applied to the flotation testing, much clearer conclusions are drawn, and tighter metal balances achieved. This all results in lower levels of error in the metallurgical test data, reducing project risk, offering significantly shorter project schedules and better startup performance for the project. XPS is prepared to use these modern practices to support your next project.

For further information, please contact:

*Dr. Norm Lotter, Consulting Metallurgist
norman.lotter@xps.ca*

or

*Ms. Elizabeth Whiteman, Senior Geoscientist
elizabeth.whiteman@xps.ca*



Co-authors (left to right) Prof. Dee Bradshaw, Dr. Norm Lotter and Ms. Elizabeth Whiteman.

EIT Experience: From the Great White North to Down Under

XPS has been managing an Engineer in Training program (EIT) for over 15 years. The objective of the XPS EIT program is to recruit, develop, and retain engineering talent as a viable means of supporting longer term succession planning across the metallurgical operations. The Engineer Development Program is intended to give new hires broad exposure and training across the various Glencore Xstrata metallurgical sites. In a two-year time frame, the mentored EIT is exposed to a diverse range of assignments in order to provide a foundation for career development while providing value to the organization. Each EIT's program is unique and the success of the program is dependent upon Glencore Xstrata operations and technology businesses providing supervised rotations/projects at their operating concentrators, smelters, refineries and testing facilities.

Tina Emamverdi, one of the XPS EITs, recently documented her experience. We hope you enjoy her article and welcome comments and questions on this unique program.



The EIT program at XPS gave me the opportunity to build a strong foundation for my engineering career. I started out at the Extractive group in XPS for my first rotation. Even though that was my first rotation I was given the chance to manage my first project which required performing test work, analyzing the data, discussing the findings with the client and writing a detailed report. For this project I was looking at the effectiveness of some chemical particles in absorbing mercury from concentrated sulphuric acid. I found it challenging to accept scientific possibilities do not always translate to practical solutions.

The importance of problem solving with strict time constraints became more obvious when I started my second rotation at the Sudbury nickel smelter. My assignments were focused on analyzing PI data to provide feedback to improve roaster and furnace operation. Also I calculated the cost savings associated with installing VFD system on the blowers in the converter aisle. During this rotation I was able to spend time with the operations crew and technicians to learn more about the operation, day-to-day challenges and the short and long-term mitigation planning. I really enjoyed this

experience because it allowed me to challenge and improve my knowledge while finding solutions through different resources.

My third rotation at the Strathcona concentrator was another opportunity to enhance my technical and interpersonal skills. I was responsible for the operation of the slimes thickener and was required to monitor the thickener online time. The thickener discharge line would freeze-up during the winter months due to the line routing and shut down procedures. Working with operations and maintenance, I arranged for the line inspection to avoid the line freeze-up and initiated a more consistent, robust procedure. This required not only understanding the hydraulic challenges but also ensuring all crews and personnel are on the same page in implementing the new procedure. I initiated a detailed analysis of the slimes thickener online time and recorded all the findings for future reference and benchmarking. This rotation ended in February 2013 while it was -45°C in Sudbury.

The transition from Strathcona to my last rotation was an extraordinary experience because I arrived in Australia in the middle of summer. The sight of palm trees

excited me since it made me feel like I was on vacation. I started working with Xstrata Technology (XT) as an operator in a coal pilot plant which was set up in a CHPP-coal handling and preparation plant. The position required traveling five days a week for six month period. I adapted to hotel life and air travel and during this journey, I learned a lot about my strengths, weaknesses and boundaries. I had an opportunity to work with a team of experts who taught me a lot about practical engineering solutions and project management.

As my rotations are coming to an end, I've realized I am interested in engineering project management. It's been an amazing experience; learning about the field of engineering, learning about myself and learning about the world down under.

*Tina Emamverdi, E.I.T.
tina.emamverdi@xps.ca*



Process Control



Process Control Solutions

Process Mineralogy

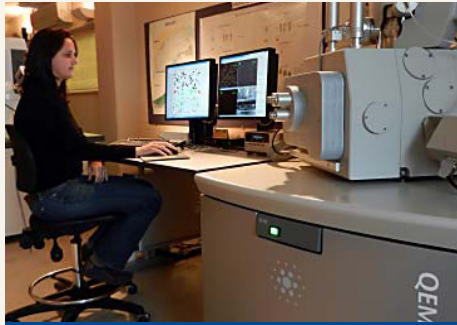

Quantitative Mineralogy, Mineral Processing, Sampling & Statistics

Plant Support



In Plant Support Services, Start up & Commissioning

Extractive Metallurgy



Metallurgy, Pyrometallurgical Modeling, Piloting & Testwork

Materials Technology



Materials Selection & Equipment Failure Analysis & Prevention

XPS is a licensed metallurgical consulting, technology and test services business.

We offer industry leading expertise covering:

- ◆ Quantitative Mineralogy (QEMSCAN and Microprobe)
- ◆ Metallurgical Flowsheet Development
- ◆ Operational Support
- ◆ Process Monitoring and Control Solutions (Mining and Processing)
- ◆ Asset Integrity Management

for most commodities including: *gold, nickel, copper, zinc, PGEs, rare earth and industrial minerals.*